

VERSA BEAM

Modular Integrated Fixture



LOW VOLTAGE

LINE VOLTAGE

SMART PRODUCTS

METAL WORKS

SOLAR PRODUCTS

RESOURCES

DESCRIPTION

The Brilliance Versa Beam is designed to be an easy-to-install, versatile light source. The Versa Beam can be used to achieve nearly any lighting configuration in landscape lighting designs. Because of its modular design, the Versa Beam can be used in hanging applications, hardscape applications, in ground applications, and overall landscape lighting. It provides indirect light for interest, as well as safety. It is dimmable with the Brilliance Dimmer and most magnetic transformers. ETL Certified for UL 1838 and CSA C22.2 Standards.

All configuration options use the same light engine with 3W, 180 lumen output, 8-15 VAC, and 90 CRI. The brass light engine housing ensures the Versa Beam dissipates heat efficiently while withstanding harsh elements and is rated IP 65. Best of all, the Versa Beam comes fully assembled with finish and configuration option of your choice already attached, so it is ready to use out of the box.

If used as a directional light, the 30 degree optic is pre-installed. If you prefer the 15, or 60 degrees, choose the optic of your choice from the interchangeable options, or remove the optic for a wider beam angle. Then, simply install the fixture in one of its many applications.

In hardscape and masonry applications, the Versa Beam is designed to be recessed into standard 1" electrical conduit, making rough-ins simple, without the need for complicated back boxes or pour sleeves.

Standard Versa Beam Light Engine



Brass (BR)

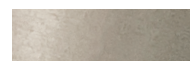

Nickel (NI)



Brass + Black (BK)





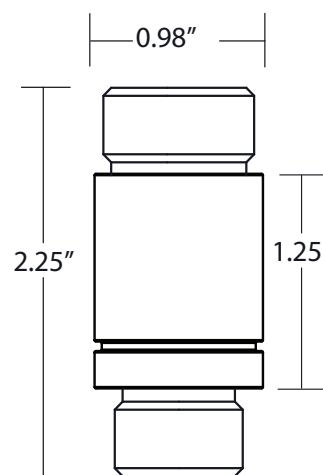





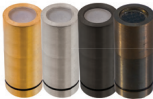

Weathered Brass (WB)

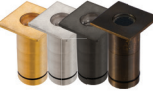

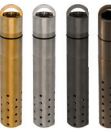
Standard Versa Beam Light Engine

VERSA BEAM

Use	Areas with Elevation Changes, Hardscape, Hanging or Overall Landscape Lighting Recommended Drill bit size: 1 5/16" (1.3125")
Finish	Brass, Nickel, Brass + Black, and Weathered Brass
Includes	Versa Beam Light Engine, 12ft. Lead, See each configuration for additional items included
Warranty	5-Year Warranty on Versa Beam Fixtures

VERSA BEAM CONFIGURATIONS		2700K	3000K	
VB-01	CAP: Uplighting applications <i>Includes Cap, Light Engine, Optics (15°, 30°, 60°), Honeycomb Louver, & Bamboo/Polypropylene Mounting Stake</i>	VB-01-BR-2700 VB-01-BK-2700 VB-01-NI-2700 VB-01-WB-2700	VB-01-BR-3000 VB-01-BK-3000 VB-01-NI-3000 VB-01-WB-3000	
VB-02	ROUND FLANGE: Up lighting, path marker lighting, or recessed lighting applications <i>Includes Round Flange, Light Engine, Optics (15°, 30°, 60°), & Honeycomb Louver</i>	VB-02-BR-2700 VB-02-BK-2700 VB-02-NI-2700 VB-02-WB-2700	VB-02-BR-3000 VB-02-BK-3000 VB-02-NI-3000 VB-02-WB-3000	
VB-03	SQUARE FLANGE: Up lighting, path marker lighting, or recessed lighting applications <i>Includes Square Flange, Light Engine, Optics (15°, 30°, 60°), & Honeycomb Louver</i>	VB-03-BR-2700 VB-03-BK-2700 VB-03-NI-2700 VB-03-WB-2700	VB-03-BR-3000 VB-03-BK-3000 VB-03-NI-3000 VB-03-WB-3000	
VB-04	6" ACRYLIC BUBBLE ROD: Down lighting and ornamental lighting applications <i>Includes 6" Acrylic Bubble Rod, Light Engine, Hanging Loop, & Bamboo/Polypropylene Mounting Stake</i>	VB-04-BR-2700 VB-04-BK-2700 VB-04-NI-2700 VB-04-WB-2700	VB-04-BR-3000 VB-04-BK-3000 VB-04-NI-3000 VB-04-WB-3000	
VB-05	12" ACRYLIC BUBBLE ROD: Down lighting and ornamental lighting applications <i>Includes 12" Acrylic Bubble Rod, Light Engine, Hanging Loop, & Bamboo/Polypropylene Mounting Stake</i>	VB-05-BR-2700 VB-05-BK-2700 VB-05-NI-2700 VB-05-WB-2700	VB-05-BR-3000 VB-05-BK-3000 VB-05-NI-3000 VB-05-WB-3000	
VB-06	PERFORATED SHIELD: Down lighting and accent lighting applications <i>Includes Perforated Shield, Light Engine, Hanging Loop</i>	VB-06-BR-2700 VB-06-BK-2700 VB-06-NI-2700 VB-06-WB-2700	VB-06-BR-3000 VB-06-BK-3000 VB-06-NI-3000 VB-06-WB-3000	
VB-07	ROUND 4 WINDOW: Path marker applications <i>Includes Round 4 Window, Light Engine</i>	VB-07-BR-2700 VB-07-BK-2700 VB-07-NI-2700 VB-07-WB-2700	VB-07-BR-3000 VB-07-BK-3000 VB-07-NI-3000 VB-07-WB-3000	
VB-08	SQUARE 4 WINDOW: Path marker applications <i>Includes Square 4 Window, Light Engine</i>	VB-08-BR-2700 VB-08-BK-2700 VB-08-NI-2700 VB-08-WB-2700	VB-08-BR-3000 VB-08-BK-3000 VB-08-NI-3000 VB-08-WB-3000	
VB-09	ROUND EYEBROW: Path marker lighting and hardscape accent lighting applications <i>Includes Round Eyebrow, Light Engine</i>	VB-09-BR-2700 VB-09-BK-2700 VB-09-NI-2700 VB-09-WB-2700	VB-09-BR-3000 VB-09-BK-3000 VB-09-NI-3000 VB-09-WB-3000	
VB-10	SQUARE EYEBROW: Path marker lighting and hardscape accent lighting applications <i>Includes Round Eyebrow, Light Engine</i>	VB-10-BR-2700 VB-10-BK-2700 VB-10-NI-2700 VB-10-WB-2700	VB-10-BR-3000 VB-10-BK-3000 VB-10-NI-3000 VB-10-WB-3000	
VB-11	KNUCKLE, SHIELD, AND CAP: Directional lighting, up lighting, or down lighting if used with a standard mount <i>Includes Knuckle, Shield, Cap, Light Engine, Optics (15°, 30°, 60°), & Honeycomb Louver, & Bamboo/Polypropylene Mounting Stake</i>	VB-11-BR-2700 VB-11-BK-2700 VB-11-NI-2700 VB-11-WB-2700 VB-11-WH-2700	VB-11-BR-3000 VB-11-BK-3000 VB-11-NI-3000 VB-11-WB-3000 VB-11-WH-3000	
VB-12	ACRYLIC CAP: Uplighting applications <i>Includes Acrylic Cap, Light Engine</i>	VB-12-BR-2700 VB-12-BK-2700 VB-12-NI-2700 VB-12-WB-2700		

VERSA BEAM SOIL APPLICATIONS

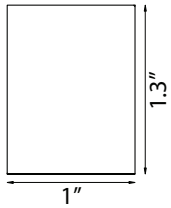

VB-01 | Cap

Includes Cap, Light Engine, Optics (15°, 30°, 60°), Honeycomb Louver, & Bamboo/Polypropylene Mounting Stake

	2700K	3000K
Brass	VB-01-BR-2700	VB-01-BR-3000
Black Brass	VB-01-BK-2700	VB-01-BK-3000
Nickel	VB-01-NI-2700	VB-01-NI-3000
Weathered Brass	VB-01-WB-2700	VB-01-WB-3000

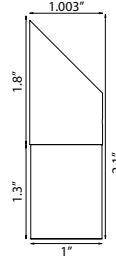

VB-11 | Knuckle, Shield, Cap

Includes Knuckle, Shield, Cap, Light Engine, Optics (15°, 30°, 60°), Honeycomb Louver, & Bamboo/Polypropylene Mounting Stake

	2700K	3000K
Brass	VB-11-BR-2700	VB-11-BR-3000
Black Brass	VB-11-BK-2700	VB-11-BK-3000
Nickel	VB-11-NI-2700	VB-11-NI-3000
Weathered Brass	VB-11-WB-2700	VB-11-WB-3000

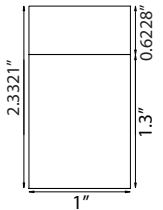
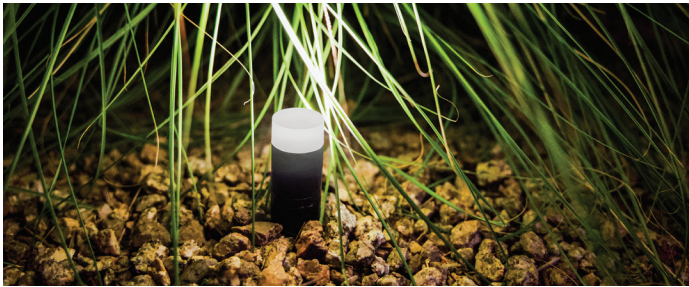

VB-12 | Acrylic Cap

Includes Acrylic Cap, Light Engine

	2700K
Brass	VB-12-BR-2700
Black Brass	VB-12-BK-2700
Nickel	VB-12-NI-2700
Weathered Brass	VB-12-WB-2700

VERSA BEAM FLANGE + OPTIC APPLICATIONS



VB-02 | Round Flange

Includes Round Flange, Light Engine, Optics (15°, 30°, 60°), & Honeycomb Louver

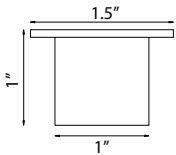

	2700K	3000K
Brass	VB-02-BR-2700	VB-02-BR-3000
Black Brass	VB-02-BK-2700	VB-02-BK-3000
Nickel	VB-02-NI-2700	VB-02-NI-3000
Weathered Brass	VB-02-WB-2700	VB-02-WB-3000

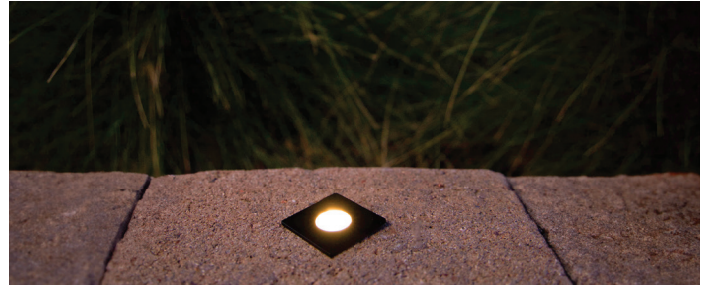

VB-03 | Square Flange

Includes Square Flange, Light Engine, Optics (15°, 30°, 60°), & Honeycomb Louver

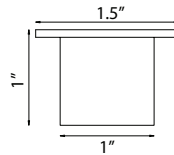

	2700K	3000K
Brass	VB-03-BR-2700	VB-03-BR-3000
Black Brass	VB-03-BK-2700	VB-03-BK-3000
Nickel	VB-03-NI-2700	VB-03-NI-3000
Weathered Brass	VB-03-WB-2700	VB-03-WB-3000

VERSA BEAM FLANGE APPLICATIONS



VB-07 | Round 4 Window

Includes Round 4 Window, Light Engine

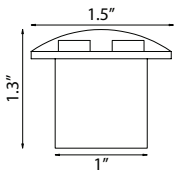

	2700K	3000K
Brass	VB-07-BR-2700	VB-07-BR-3000
Black Brass	VB-07-BK-2700	VB-07-BK-3000
Nickel	VB-07-NI-2700	VB-07-NI-3000
Weathered Brass	VB-07-WB-2700	VB-07-WB-3000



VB-08 | Square 4 Window

Includes Square 4 Window, Light Engine

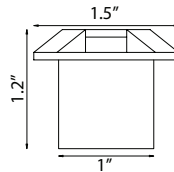

	2700K	3000K
Brass	VB-08-BR-2700	VB-08-BR-3000
Black Brass	VB-08-BK-2700	VB-08-BK-3000
Nickel	VB-08-NI-2700	VB-08-NI-3000
Weathered Brass	VB-08-WB-2700	VB-08-WB-3000



VB-09 | Round Eyebrow

Includes Round Eyebrow, Light Engine

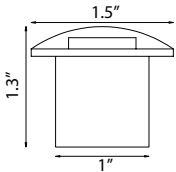

	2700K	3000K
Brass	VB-09-BR-2700	VB-09-BR-3000
Black Brass	VB-09-BK-2700	VB-09-BK-3000
Nickel	VB-09-NI-2700	VB-09-NI-3000
Weathered Brass	VB-09-WB-2700	VB-09-WB-3000



VB-10 | Square Eyebrow

Includes Square Eyebrow, Light Engine

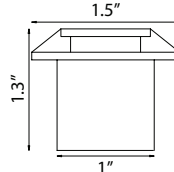

	2700K	3000K
Brass	VB-10-BR-2700	VB-10-BR-3000
Black Brass	VB-10-BK-2700	VB-10-BK-3000
Nickel	VB-10-NI-2700	VB-10-NI-3000
Weathered Brass	VB-10-WB-2700	VB-10-WB-3000

VERSA BEAM HANGING APPLICATIONS

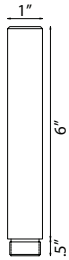

VB-04 | 6" Acrylic Bubble Rod

Includes 6" Acrylic Bubble Rod, Light Engine, Hanging Loop, & Bamboo/Polypropylene Mounting Stake

	2700K	3000K
Brass	VB-04-BR-2700	VB-04-BR-3000
Black Brass	VB-04-BK-2700	VB-04-BK-3000
Nickel	VB-04-NI-2700	VB-04-NI-3000
Weathered Brass	VB-04-WB-2700	VB-04-WB-3000

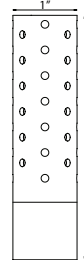

VB-06 | Perforated Shield

Includes Perforated Shield, Light Engine, & Hanging Loop

	2700K	3000K
Brass	VB-06-BR-2700	VB-06-BR-3000
Black Brass	VB-06-BK-2700	VB-06-BK-3000
Nickel	VB-06-NI-2700	VB-06-NI-3000
Weathered Brass	VB-06-WB-2700	VB-06-WB-3000



VB-05 | 12" Acrylic Bubble Rod

Includes 12" Acrylic Bubble Rod, Light Engine, Hanging Loop, & Bamboo/Polypropylene Mounting Stake

	2700K	3000K
Brass	VB-05-BR-2700	VB-05-BR-3000
Black Brass	VB-05-BK-2700	VB-05-BK-3000
Nickel	VB-05-NI-2700	VB-05-NI-3000
Weathered Brass	VB-05-WB-2700	VB-05-WB-3000