



BRILLIANCE STRIP LIGHT

PRODUCT & INSTALLATION

GUIDE

BRILLIANCE LED[®]
A HIGHER LIGHT FORM[®]

TABLE OF CONTENTS

BEST PRACTICES	4
BRILLIANCE STRIP LIGHT	5
ACCESSORIES	6
POWER FEED KIT.....	6
CHANNEL W/ GROOVE.....	6
DIFFUSER.....	6
JUMPER CONNECTOR KIT.....	6
“T” POWER FEED CONNECTOR KIT.....	6
CHANNEL W/ GROOVE & GLARE SHIELD	6
ATTACHMENT CLIP	6
90° JUMPER CONNECTOR KIT	6
END CAP KIT.....	6
CLIP & SCREW KIT.....	6
STEALTH CONNECTOR SHIELDS	6
ACCESSORY SPECIFICATIONS	7
ASSEMBLY INSTRUCTIONS	8



STOP!

**FAILURE TO FOLLOW
INSTRUCTIONS WILL
VOID WARRANTY**

BEST PRACTICES

A

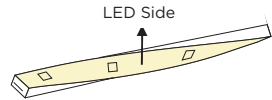
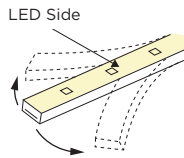
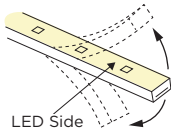

B

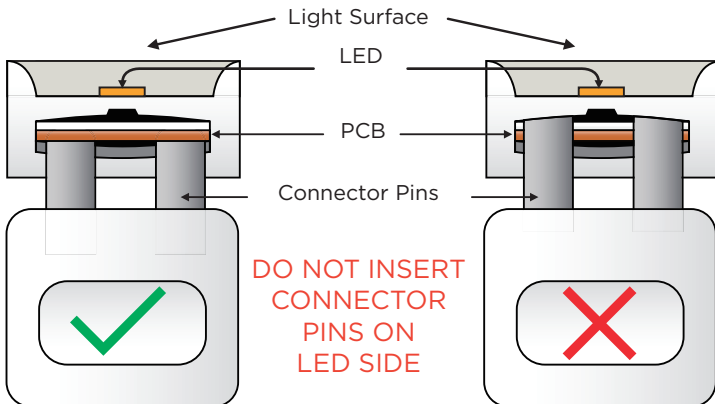

BEST PRACTICES

C

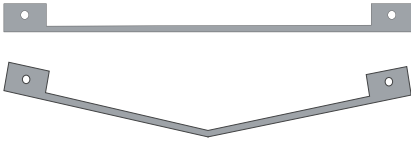

Stealth Connector Shield¹ (SCS)

- Can be bent more than 90°
- Can be field cut for power feed connector and end caps
- Can be painted

STEP 1: Shape the SCS to the desired angle.

STEP 2: The tabs on either side of the SCS will fit into the rear groove of the channel. If desired, use instant adhesive to connect the SCS to the top of the channel.

D



CUTTING: Use a PVC cutting device to cut the strip light. Utility knives and/or a saw create uneven and tilted edges, and water damage may occur.

¹ While the aluminum extrusion material will not be adversely affected by conventional Ultraviolet (UV) and Infrared (IR) exposure, the black dye used in the anodizing process is an organic material and will experience fading over time depending on the level of exposure to Ultraviolet (UV) and Infrared (IR) from sunlight. The amount of fading will be determined by the above stated factors. For this reason, Brilliance LED makes no warranty or guarantee for discoloration when this product is used in an outdoor application or is exposed to direct sunlight.

BRILLIANCE STRIP LIGHT



DESCRIPTION

The Brilliance AC flexible Strip Light is rated for outdoor use. The LEDs on this Strip Light are encased in non-yellowing material. Brilliance Strip Light provides great accent lighting for stairs, railings, and overhangs, plus it installs easily. Incorporate it to a new project or connect it directly to an existing 8 to 16 VAC landscape lighting system.



FEATURES

- Dimmable with most magnetic transformers
- Recommended max. length per power feed is 40 feet
- Available in 82.25 ft reels (25 meters) or 32.8 ft reels (10 meters)
- Enhanced ESD (Electro-Static Discharge) protection (IEC-61000-4-2)
- UL Certified E487030

NEC* Article 411.5 (B): Lighting systems shall be installed not less than 3m (10ft) horizontally from the nearest edge of the water, unless permitted by Article 680.

STRIP LIGHT SPECS

Wattage	1.8 W per meter
Volt Amps	0.6 W per foot
Lumens	45 LM per foot
Kelvin Temperature	2700, 3000, 5000
Color	Amber (82 ft. only) Blue (82 ft. only)
Operating Range	8-16 VAC/DC
CRI	80
IP	65
Lamp Life (hours)	35,000
Warranty (years)	3

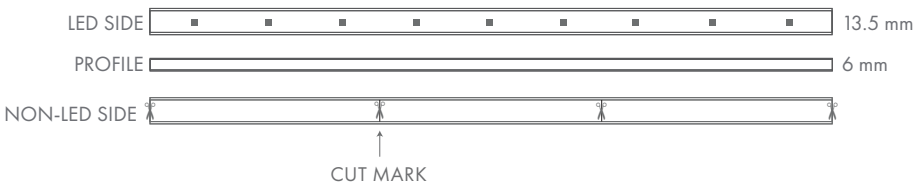

ACCESSORIES



Double-Sided Connector Kit
Part # BRI-SL-A-DSC
 1 - Double-Sided Connector
 2 - Clear Plastic Retainers
 2 - Metal Anti-Slip Plates
 1 - Heat-Shrink Tube



Jumper Connector Kit
Part # BRI-SL-A-JC
 1 - Jumper Connector
 2 - Clear Plastic Retainers
 2 - Metal Anti-Slip Plates
 2 - Heat-Shrink Tubes



90° Jumper Connector Kit
Part # BRI-SL-A-90
 1 - Jumper Connector
 2 - Clear Plastic Retainers
 2 - Metal Anti-Slip Plates
 2 - Heat-Shrink Tubes



Power Feed Kit
Part # BRI-SL-A-PF
 1 - Power Feed
 1 - Clear Plastic Retainer
 1 - Metal Anti-Slip Plate
 1 - Heat-Shrink Tube



"T" Power Feed Connector Kit
Part # BRI-SL-A-T
 1 - "T" Power Feed Connector
 2 - Clear Plastic Retainers
 2 - Metal Anti-Slip Plates
 2 - Heat-Shrink Tubes



End Cap Kit
Part # BRI-SL-A-EC
 1 - End Cap
 1 - Light Shield
 1 - Heat-Shrink Tube



Strip Light Channel w/ Groove
Part # BRI-SL-A-C
 1m (3.2') Channel sections
 5 - Screws



Strip Light Channel w/ Groove & Glare Shield
Part # BRI-SL-A-C2
 1m (3.2') Channel sections
 5 - Screws



Clip & Screw Kit
Part # BRI-SL-A-C&S
 50 - Plastic Clips
 100 - Screws



Diffuser
Part # BRI-SL-A-CD
 1m (3.2') section



Attachment Clip
Part # BRI-SL-A-AC

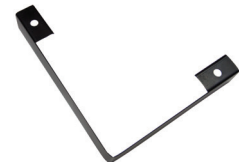

Stealth Connector Shields¹
Part # SL-SCS (8")
Part # SL-SCSW/FACIA (w/ Facia)
 (SEE FIG. C)

¹While the aluminum extrusion material on accessories will not be adversely affected by conventional Ultraviolet (UV) & Infrared (IR) exposure, the black dye used in the anodizing process is an organic material and will experience fading over time depending on the level of exposure to Ultraviolet (UV) & Infrared (IR) from sunlight. The amount of fading will be determined by the above stated factors. For this reason, Brilliance LED makes no warranty or guarantee for discoloration when this product is used in an outdoor application or is exposed to direct sunlight.

ACCESSORY SPECIFICATIONS

Jumper Connector Kit (# BRI-SL-A-JC)

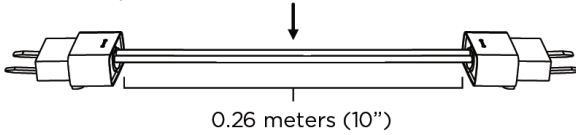

"T" Power Feed Connector Kit

(# BRI-SL-A-T)

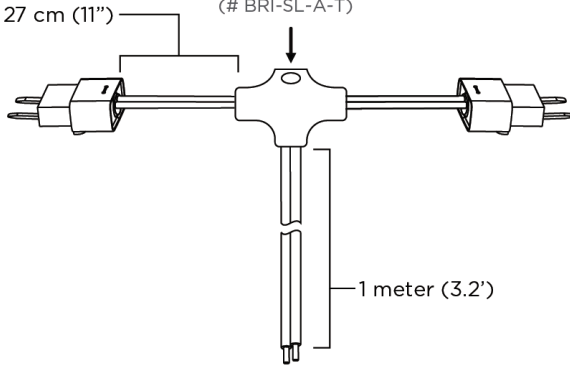

90° Jumper Connector Kit

(# BRI-SL-A-90)

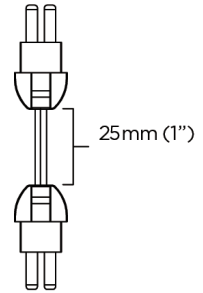

Clip+Screw Kit (# BRI-SL-A-C&S)

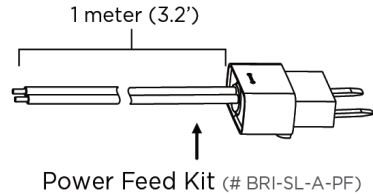
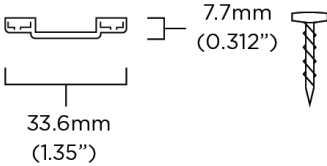

Strip Light Channel (Gen 2)

w/ Groove (# BRI-SL-A-C)

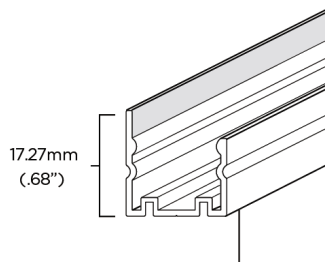
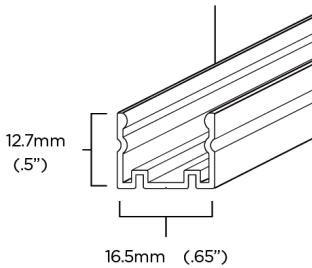

Strip Light Channel (Gen 2)

w/ Groove & Glare Shield

(# BRI-SL-A-C2)

ASSEMBLY INSTRUCTIONS



Failure to follow these instructions will void the warranty.

1. Cut the strip light to length. Cut only on the dotted scissor lines shown on the non-LED side.

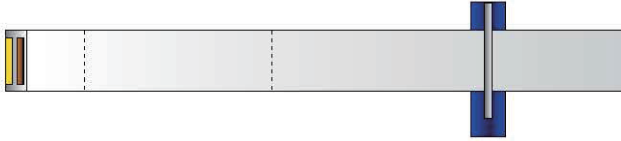

2. Slide the heat shrink on the strip light. Then slide the plastic retainer on. Make sure the ribbed side faces the non-LED side.

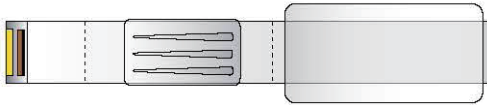

3. With bump on power feed facing the underside of the strip, connect the power feed.

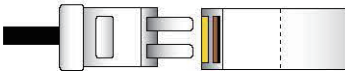

4. Insert the Connector Pins on the PCB Side (Copper). For close-up instruction, see figure B in the Best Practices section.



5. Apply silicone to the connector pin base.

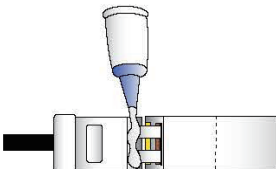

- 6.** Connect the strip light and the power feed tightly until silicone squeezes out.

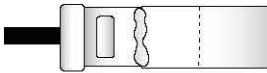

- 7.** Place the anti-slip plate on the non-LED side of the strip.



- 8.** Slide the plastic retainer over the anti-slip plate.



- 9.** Apply silicone around the plastic retainer and the power feed cable.

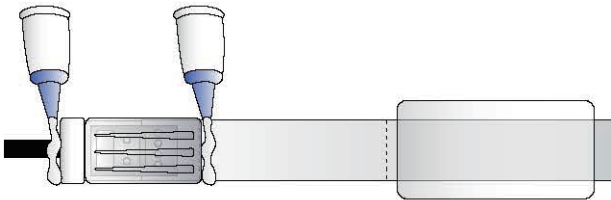

- 10.** Slide the heat-shrink tube over the entire connection.



ASSEMBLY INSTRUCTIONS

Continued

11. Use a heat gun to seal them together.

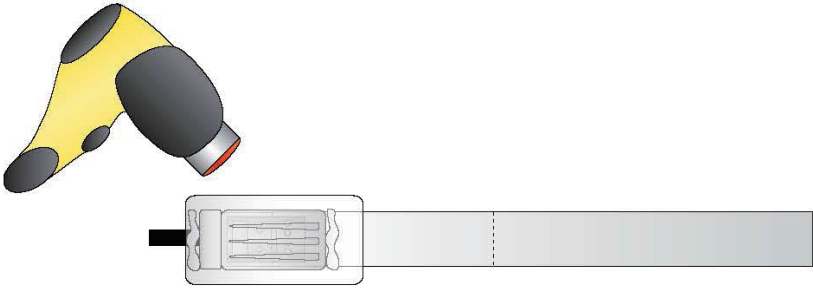

12. Connection is now complete. Allow any additional silicone to squeeze out, and wipe off the excess.



13. Place the light shield inside of the end cap.



14. Add silicone inside of the end cap.



- 15.** Place the end cap on with grooved side facing the non-LED side of strip light. Press firmly to attach.



- 16.** Apply silicone around the end cap.

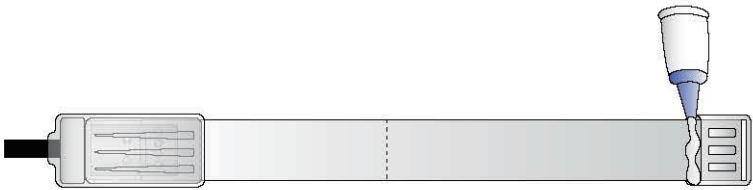

- 17.** Slide the heat shrink tube over the end cap.



- 18.** Use a heat gun to seal them together. The end cap is now connected, and the strip light assembly is finished from end to end.

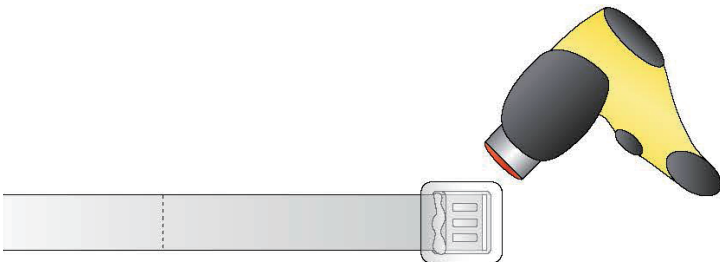



brillianceled.com | 800.867.2108
7202 E Cave Creek Rd, Suite 3A
PO Box 2281 Carefree, AZ 85377